

SSC165 SSC210 SSC250 Owner's Manual



Safety Speed Manufacturing
13943 Lincoln Street NE
Ham Lake, MN 55304
763-755-1600 Fax: 763-755-6080
www.safetyspeed.com
sales@safetyspeed.com

A message from all of us at SAFETY SPEED MANUFACTURING:

Thank you for purchasing a Safety Speed Substrate Cutter. We take pride in providing the best product in the market.. Each SSM product is designed to give years of dependable service. Our machines are built from the finest components we can specify, and every machine is individually assembled by our employees, some of whom have been building these products for more than 30 years. We appreciate your choosing our products for your application.

Employees of Safety Speed
Ham Lake, Mn

WARRANTY

Safety Speed warrants the parts and workmanship of this tool, for one year from the date of manufacture. Safety Speed will repair or replace, at our cost, any component that is determined to be defective. Such repair or replacement is limited to providing satisfactory replacement parts from the factory. Safety Speed assumes no responsibility for making repairs on site. Any parts returned to the factory must be returned freight prepaid.

Safety Speed assumes no responsibility for any damage or accidents resulting from the misuse of this tool, its misapplication, or failure to follow precautionary safety measures. Safety Speed assumes no responsibility for any consequential damage or loss of production. Safety Speed will not be responsible for claims made for machines that are not used or maintained in the normal course of business, used for applications not intended, or modified in any way.

**This manual covers the following Safety Speed models:
SSC165, SSC210, and SSC250 Substrate Cutters**

Thank you for purchasing a Safety Speed product. Manufactured to a high standard this product will, if used according to these instructions and properly maintained, give you years of trouble free performance.



IMPORTANT: PLEASE READ THESE INSTRUCTIONS CAREFULLY. NOTE THE SAFE OPERATIONAL REQUIREMENTS, WARNINGS & CAUTIONS. USE THE PRODUCT CORRECTLY AND WITH CARE FOR THE PURPOSE FOR WHICH IT WAS INTENDED. FAILURE TO DO SO MAY CAUSE DAMAGE OR PERSONAL INJURY, AND WILL INVALIDATE THE WARRANTY.

PLEASE KEEP INSTRUCTIONS SAFE FOR FUTURE USE.

ASSEMBLY

1. CONTENTS

CAUTION: THE COUNTERBALANCE WEIGHT AND COUNTERBALANCE CORD CAN BECOME SEPERATED IN TRANSIT, RECONNECT BEFORE STARTING THE ASSEMBLY PROCESS.

After unpacking the SSC 165/210/250, check to make sure that you have all the parts and that there is no damage. All fasteners have been loosely fixed in place to aid assembly. These can come loose in transit, do not throw any packaging away until assembly is complete.

1.1 SSC 165/210/250 COMPONENTS:

- Vertical assembly
- Horizontal assembly
- Legs (1 x Left Hand (LH), 1 x Right Hand (RH), the RH leg includes the squaring adjustment mechanism)
- Material supports (165/210 has 8x) (250 has 10x)
- Scale set (not visible on photograph)
- Tool box (containing Toolholder #1,#2, #3, Toolholder stop, Utility blades x 100, 2mm Allen key, 4 and 5mm Allen key, Laser assembly and Wall mount bracket).



2. ASSEMBLY (BEGIN WITH THE VERTICAL ASSEMBLY LAYING FLAT ON THE FLOOR)

2.1 Fitting the RH leg – Remove the 2 x M8 screws from the top of the RH leg and hold the leg behind the RH joining bracket. Refit the screws from the front, finger tight only. (fig. 1)



2.2 Repeat for the LH leg

2.3 Fitting the horizontal assembly – Remove the 2 flip stops, the 2 x M8 screws and the 2 x M10 screws after carefully noting their positions. Slide the horizontal assembly through the gap in the vertical assembly. Align the two inner holes in the horizontal assembly with the two corresponding holes in the machined section of the vertical assembly and refit the 2 x M10 screws loosely. The M10 screws are fitted from the rear, you may find it easier to raise the bottom end of the machine to do this. The tool box supplied (fig.11) is ideal for this purpose. Align the two outer holes in the horizontal assembly with the corresponding holes in the legs and refit the 2 x M8 screw assemblies loosely. The M8 screws are fitted from the front with the black nylon spacer between the horizontal assembly and the legs (fig.3).

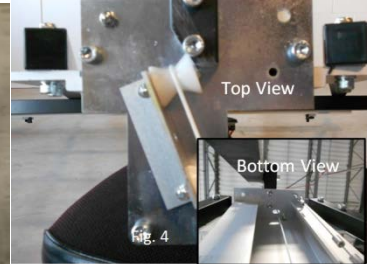

2.4 Fitting the wall mounting bracket – Raise the top end of the machine, remove the 2 x M8 screws from the wall mounting bracket and fit to the top plate as shown (fig. 4). Refit the 2 x M8 screws finger tight only. Tighten the 2 x M8 screws at the top of each leg (fig. 1) and get help to lift the machine into position against the wall in the desired location. The wall mounting bracket should lay flush against the wall, mark the position of the two V's with a pencil (fig. 5). Move the machine away and remove the wall mounting bracket. Attach the bracket to the wall with appropriate fixings then reposition the machine and fasten to the bracket.



***If you purchased the optional stand, see page 12**

2.5 Tighten the 2 x M10 screws fixing the horizontal assembly to the vertical assembly (fig. 2) and the 2 M8 screws fixing the horizontal assembly to the legs (fig. 3).

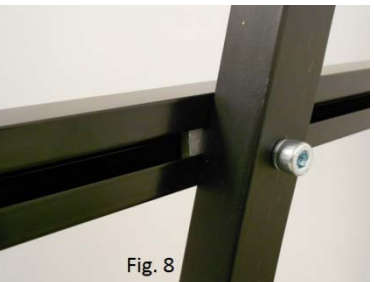
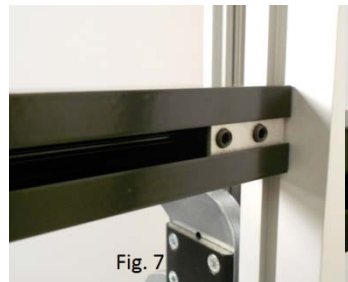

2.6 Fitting the material supports – Loosen the 8 clamps (10 for SSC250) attached to the legs and slide all the material supports into position as shown (fig. 6). You may need to undo the grub screws fitted to each fixing bracket. Make sure that each support is level before tightening the two grub screws in the fixing bracket (fig. 7) and the M8 screw in the clamp (fig. 8).

2.7 Fit the tool holder stop block into the bottom of the vertical aluminum extrusion.

Locate the aluminum block with all supplied components seen (fig 9A).

Install the stop block into the slot as shown (fig 9B & fig 9C).



Fig. 9A

Fig. 9B

Install the additional block into position (fig 9D & fig 9E).



Fig. 9C

Fig. 9D

Fig. 9E

Tighten with supplied Allen hex key (fig 9F).
Stop bumper bolt is installed into the exposed hole (fig 9G).



Fig. 9F

Fig. 9G

Locate the nut to the bottom of the bolt (fig 9H), to allow it to clear the lip of the aluminum extrusion. Tighten down from there to get the bolt on relative position as shown. You can make fine adjustments once you start moving your knife slide (fig 9I).



Fig. 9H

Fig. 9I

2.8 Extend the support leg so that it firmly touches the floor (fig. 10).

2.9 Fitting the tool box – Fit the tool box to the rear of the horizontal assembly as shown (fig. 11).



Fig. 10

Fig. 11

2.10 Set the legs so the horizontal adjuster appears as seen (fig12)



Fig. 12

3. CHECKING THE SSC 165/210/250 FOR SQUARENESS

TO PRODUCE ACCURATE RESULTS, THE HORIZONTAL ASSEMBLY NEEDS TO BE FIXED AT EXACTLY 90 DEGREES TO THE VERTICAL ASSEMBLY. TO DO THIS SELECT A PIECE OF FOAM BOARD 1/8"-1/4" AT LEAST 24" X 40" IN SIZE. THE LARGER THE BOARD THE GREATER THE ACCURACY.

3.1 Remove the toolholder's clamping plate to fit the utility blades into position (fig. 13), see pg. 8 for more detail. Insert the knife cartridge, and move the head to the parked position near the top of the machine.

3.2 Place the board vertically on the machine and clamp in position. Make sure that the bottom edge is in firm contact with the horizontal assembly and make a cut by pulling the head downwards.

3.3 Unclamp the board and return the head to its parked position near the top of the machine. Turn the board over like the page in a book (NOT top to bottom) and make a second cut.

3.4 If the machine is square, the width of the board at the top will equal the width of the board at the bottom. If it does not, then follow the instructions in section 4 below.



4. ADJUSTING THE SQUARENESS

4.1 Slacken the 2 x M8 screws joining the legs to the horizontal assembly. (fig. 3)

4.2 Slacken the right hand M10 screw joining the horizontal assembly to the vertical assembly, make sure that the left hand M10 screw is tight. (fig. 2) Measure the width of the board at the top and at the bottom. If top measurement is greater than bottom turn the squaring adjuster clockwise. If top measurement is less than bottom turn the squaring adjuster anti-clockwise and push the horizontal assembly downwards.

4.3 Make another cut and measure, repeating this process until top = bottom.

4.4 Tighten the screws loosened in 4.1 and 4.2.

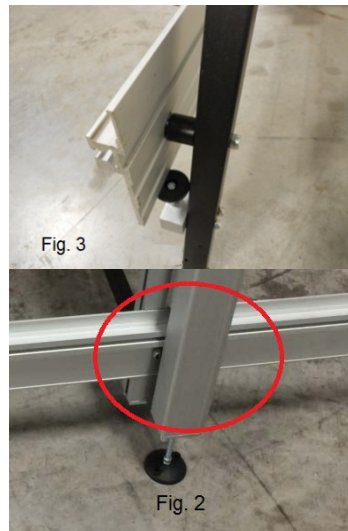

5. CALIBRATING AND FITTING THE MEASURING SCALES

5.1 VERTICAL SCALE – This measures the height of the board and is only used for reference. Take a small piece of board and accurately measure its height. Place the board in the machine so that it covers the scale recess and, with a pencil, mark a line level with the top of the board adjacent to the scale recess. Remove the vertical scale from its backing and stick in place so that the measured dimension is in line with the pencil mark.

5.2 RIGHT HAND SCALE (reads left to right) – Set the RH flip stop at approximately 8". Slide a piece of board up to this stop and make a cut. Accurately measure the size of this board. Remove the RH scale from its backing and stick in the recess with the measured dimension in line with the edge of the production stop.

5.3 LEFT HAND SCALE (reads right to left) – Repeat 5.2 using the LH flip stop.

5.4 Trim any excess .

6. FITTING AND CALIBRATING THE LASER (fig. 15)

CAUTION: NEVER LOOK DIRECTLY AT THE LASER SOURCE

6.1 Slide the laser mounting block onto the locating pin and fix the battery box to the side of the cutting head. (fig. 15)

6.2 With the cutting head in its parked position near the top of the machine, clamp a piece of foam board or something similar in place. Set the toolholder to cut only the surface of the board and not all the way through and move the head downwards to the bottom of the machine.

6.3 Remove the toolholder and move the head so that it is just above the clamped material.

6.4 Switch on the laser.

Note: The Thin line laser can be focused by turning the grooved ring on the end if needed.

6.5 Loosen the horizontal adjustment knob and slide the laser left or right so that the laser line is centered on the start of the cut line.

6.6 If the laser needs to be adjusted so that it is parallel with the cut line this is done by loosening the clamp screw and rotating the laser module within the mounting block.

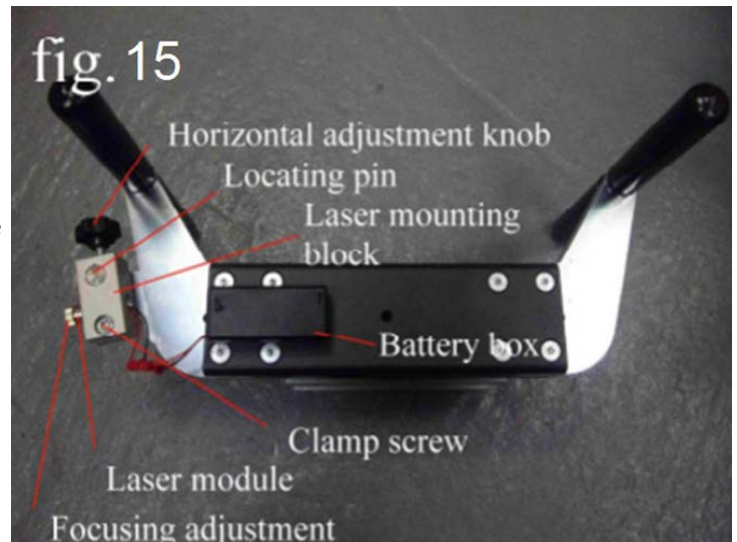

7. USING THE SSC 165/210/250

There are some general principles which apply to the proper use of the SSC 165/210/250

7.1 All cutting and scoring is done on the downward stroke.

7.2 Material to be cut can be fed from the left or right and moved to the desired dimension against the production stops. You can also sight your cut using the laser.

7.3 Fit the utility blades into the toolholder by removing the clamp plate (fig. 13), CAUTION: THE BLADES ARE SHARP, HANDLE CAREFULLY.

7.4 Insert the toolholder into the cutting head and push as far forward as the stops will allow, tighten the clamp knob and then slacken by one turn. This will allow the toolholder to move between the fully forward position for thin materials (fig.16) and the fully retracted position for thick materials (fig 17.) Remember to tighten the clamp knob before use.

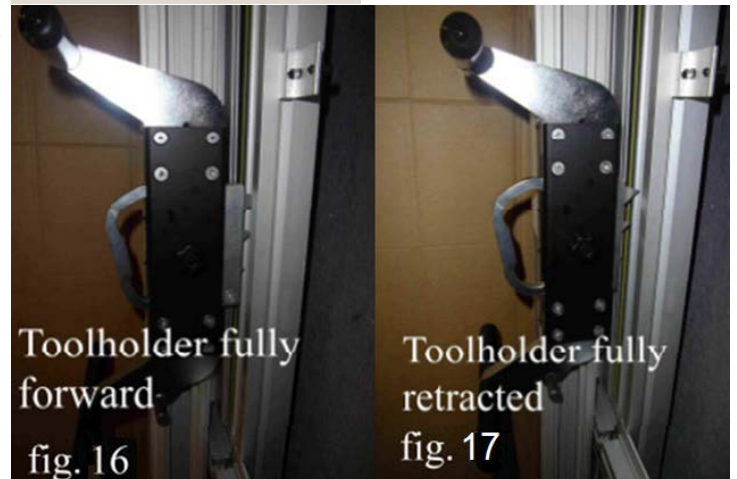

8. USING THE SSC 250 EXTENDED HANDLE

8.1 For using the SSC 250, the extended handle can be used for higher cutting by installing the handle into the hand hold position of the cutter assembly, and then using the extended handle to pull down or push up the cutter as needed. (fig18 & fig 19)

As you move towards the bottom of the frame while cutting, you remove the extended handle and use the main handle to finish your cut.



Fig. 18

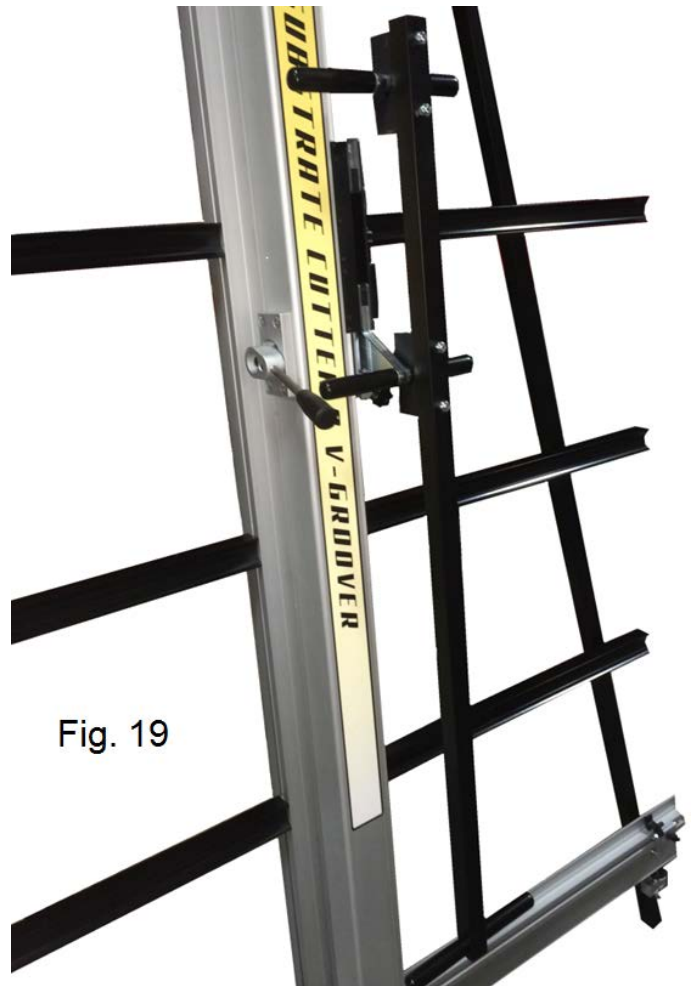

Fig. 19

9. GENERAL MAINTENANCE

9.1 Regularly clean the SSC 165/210/250 Cutter rail using a dry cloth, stubborn stains can be removed with a cloth dampened with a little water/detergent.

9.2 Silicon spray can be used to lubricate the cutting head slideway. ***NEVER USE OIL OR SPIRITS TO LUBRICATE OR CLEAN THE SLIDEWAY AS THE BEARINGS MAY BE DAMAGED.***

10. SPARE PARTS

10.1 Spare parts can be obtained by contacting us at 1-800-772-2327

Tooling

Tool cartridges are engraved with numbers which represent the type of materials usage:

- #1 Knife Cartridge-Standard Utility Blades
- #2 Aluminum Cartridge-Cutter Wheels
- #3 Acrylic Cartridge—Scoring Blade
- #4 V-Grooving Tool- V-Blades—(Optional)

Standard Knife Cartridge (SSC1)

Introduction

The knife tool is specially designed to cut softer substrates such as Foam Board, Sintra, etc. Follow these instructions for optimum safety, cut quality and performance. You will need to install three blades into you tool cartridge. Remove the tool clamp plate on the cartridge with provided Allen wrench and insert the three blades into the corresponding machined grooves (fig. 1 on this page).

Setting the Blade Depth

Place the material under the cutting arm and apply the clamp. Insert the toolholder and position the cutting head so the tip of the first blade is just scoring the material (fig.2). If the material is thin you might only use the second or third blade to perform the cut. The three blades are used to assist in cutting thicker substrates. Tighten the securing knob. You are now ready to start cutting

Replacing the Blade

Using the 4mm Allen key supplied with the machine, loosen the screws and remove the old blades. Fit the new blades and tighten the screws (fig. 1)

Spare Parts

Spare parts can be obtained by calling 1-800-772-2327.

<u>PART</u>	<u>DESCRIPTION</u>
SSC1	SC-Knife Cutter
SSC1-1	Package of 100 blades



Aluminum Composite Tool (SSC2)

Introduction

The aluminum composite cutting tool is specially designed to cut aluminum faced sheet material commonly referred to as aluminum composites up to a maximum thickness of 4mm. Follow these instructions for optimum safety, cut quality and performance.

Setting the Blade Depth

Insert the toolholder and push forward to the stop position. Tighten the securing knob and then undo by half a turn, this will allow the head to move slightly to accommodate the different thicknesses of aluminum composite.

NOTE – THERE IS NO NEED TO REMOVE THE PROTECTIVE FILM FROM THE ALUMINIUM COMPOSITE.

Making the Cut

Move the cutting head to a resting position above the height of the material to be cut.

Insert the aluminum composite into the machine so that the cutting mark on your material is lined up with your tooling or the installed laser line. Clamp the material in place.

Grasp both handles on the cutting head and firmly pull/push downwards in a slow steady manner to make the cut. Complete the cut by pulling/pushing the head down to its bottom resting place.

Unclamp the material and remove it from the machine.

Replacing the Blades

Undo the locknut and remove the spindle screw. (fig. 3 & 4)

Remove the bearings from the old wheels and insert them into the new. (fig 5)

Fit this assembly onto the spindle (beveled edge outward) and tighten the spindle screw. (fig 6)

Adjust the spindle screw as necessary to allow the wheels to turn freely and tighten the locknut.

Spare Parts

Spare parts can be obtained by calling 1-800-772-2327.

<u>PART</u>	<u>DESCRIPTION</u>
SSC2	SC-Aluminum cartridge
SSC2-1	1 set of cutting wheels

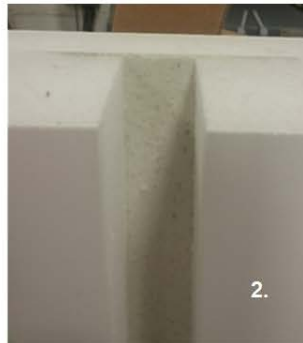

Acrylic Scoring Tool (SSC3)

Introduction

The acrylic scoring tool is specially designed to score acrylic, plexiglass and other fracture sensitive rigid plastics - enabling them to be broken along the score line. Follow these instructions for optimum safety, cut quality and performance.

Setting the Blade Depth

Place the rigid plastic you wish to score onto the machine squaring arm and apply the clamp. NOTE – THERE IS NO NEED TO REMOVE THE PROTECTIVE FILM FROM THE PLASTIC. Insert the toolholder and position the cutting head so the tip of the scoring blade is resting on top of the material (fig.1, see below). Tighten the securing knob.

Pull back the spring loaded blade holder and position the tip of the scoring blade 1mm below the top edge of the substrate (fig.2). You are now ready to create the score line.

Making the Score

Grasp both handles on the cutting head and pull/push downwards in a slow steady manner to make the score. Complete the cut by pulling/pushing the head down to its bottom resting place (fig. 3). NOTE – MOVING SLOWLY WILL CREATE A SMOOTHER EDGE.

One pass should be enough for materials up to 3mm thick. Three or more passes may be required when scoring thicker materials. This is achieved by pulling the blade back against the spring and lifting the head back to the start position. Repeat steps above as often as required, substrates vary in number of scores required.

Running the Score Line

Unclamp the material, remove it from the machine and snap by hand. NOTE – USING THE EDGE OF A TABLE OR SIMILAR WILL MAKE THIS JOB EASIER. PLACE THE SUBSTRATE SO THAT THE SCORE LINE IS ON THE EDGE OF THE TABLE AND APPLY PRESSURE TO THE PART OVERHANGING THE EDGE TO START THE RUN AND SEPERATE THE TWO PIECES (fig. 4).

Replacing the Blade

Using the 2mm Allen key supplied with the machine, loosen the M3 screw and slide out the old blade. Fit the new blade and tighten the M3 screw (fig. 5).

Spare Parts

Spare parts can be obtained by calling 1-800-772-2327.

<u>PART</u>	<u>DESCRIPTION</u>
SSC3	SC-Knife Cutter
SSC3-1	Package of 10 Scoring

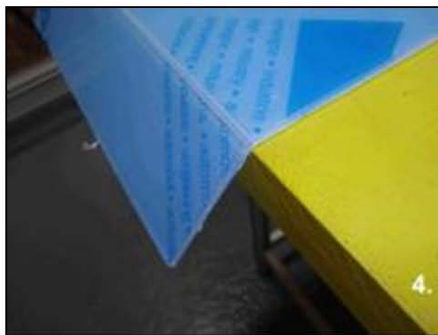

V Grooving (SSC4-Optional)

Introduction

The aluminum composite V groover is specially designed to cut a strip of material from the surface of aluminum composite sheets up to 4mm thick – enabling bending and folding of the substrate for a wide variety of applications. Follow these instructions for optimum safety, cut quality and performance.

Setting the Blade Depth

Place a sample of the aluminum composite you wish to cut onto the SSM roller base and apply the clamp. Insert the tool holder and position the cutting head so the V groove blade is resting on top of the material (fig.1).

Push the tool holder fully forward so that the plastic ramp is in total contact with the face of the material and then tighten the securing knob, (IMPORTANT – THE PLASTIC RAMP MUST BE IN FIRM CONTACT WITH THE MATERIAL SURFACE IN ORDER TO MAINTAIN A UNIFORM GROOVE DEPTH THROUGHOUT THE FULL CUTTING STROKE) (fig. 2).

Turn the depth adjustment screw using the 5mm Allen key supplied with the machine. Turn clockwise to increase the depth of cut or counter-clockwise to decrease the depth of cut (fig. 3). As a general rule, allow a minimum of 0.5mm of the material's plastic core, plus the aluminum skin, to remain after the material has been cut.

Making the Cut

Grasp both handles on the cutting head and pull/push downwards in a slow steady manner to make the cut. Complete the cut by pulling/pushing the head down to its bottom resting place (fig. 4).

Unclamp the material, remove it from the machine and bend the sheet as required (fig. 5).

Make any final adjustments to the blade depth by following the instructions in setting blade depth

No further adjustment will be required unless you change the thickness of the material to be cut.

IMPORTANT – ALWAYS ENSURE THAT THE PLASTIC RAMP IS IN FIRM CONTACT WITH THE MATERIAL SURFACE BEFORE STARTING EACH CUT.

Replacing the Blade

Using the 2mm allen key supplied with the machine, remove the two M3 screws (one on each side of the blade holder) and remove the old blade. Fit the new blade with the cutting edge pointing downwards and insert the two securing screws (fig. 6).

Spare Parts

Spare parts can be obtained by calling 1-800-772-2327.

<u>PART</u>	<u>DESCRIPTION</u>
SSC4	SC-V Grooving cartridge
SSC4-1	1 spare V Groove blade



SSC 165 SSC210 SSC250 FREE STANDING KIT

1. CONTENTS

All fastenings have been loosely fixed in place to aid assembly. These can come loose in transit, do not throw any packaging away until assembly is complete.

2. FITTING THE 165, 210 OR 250 FREE STANDING KIT

CAUTION: YOU WILL REQUIRE THE ASSISTANCE OF ANOTHER PERSON TO CARRY OUT THE FITTING OF THE FREE STANDING KIT

2.1 Remove the wall mounting bracket if you have already fitted this.

2.2 Move the counterbalance eyebolt from position A to position B (figure 1)

2.3 Fit the short arm to the vertical assembly top plate using the holes shown in fig 2.

2.4 Fit the long arm to the bottom plate using the holes shown in fig 3.

2.5 Make sure that all screws are tight.

3. GENERAL MAINTENANCE

3.1 Regularly clean the Freestanding kit using a dry cloth, stubborn stains can be removed with a cloth dampened with a little water/detergent.

3.2 Periodically check the tightness of all fixings.

4. SPARE PARTS

Spare parts can be obtained by calling 1-800-772-2327.

<u>PART</u>	<u>DESCRIPTION</u>
SSC5	SSC165 Free Standing Kit
SSC6	SSC210 Free Standing Kit
SSC7	SSC250 Free Standing Kit

